

## Features

- Low On-Resistance:  
57mΩ @  $V_{GS} = 10V$   
112mΩ @  $V_{GS} = 4.5V$
- Low Gate Threshold Voltage
- Low Input Capacitance
- Fast Switching Speed
- Low Input/Output Leakage
- **Lead Free By Design/RoHS Compliant (Note 2)**
- **"Green" Device (Note 3)**
- **Qualified to AEC-Q101 Standards for High Reliability**

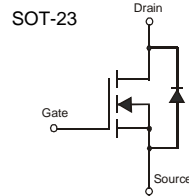

TOP VIEW



Equivalent Circuit

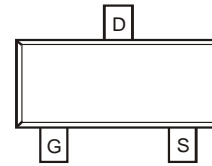

TOP VIEW

## Mechanical Data

- Case: SOT-23
- Case Material: Molded Plastic, "Green" Molding Compound. UL Flammability Classification Rating 94V-0
- Moisture Sensitivity: Level 1 per J-STD-020D
- Terminals: Finish – Matte Tin annealed over Copper leadframe. Solderable per MIL-STD-202, Method 208
- Terminal Connections: See Diagram
- Marking Information: See Page 4
- Ordering Information: See Page 4
- Weight: 0.008 grams (approximate)

## Maximum Ratings @ $T_A = 25^\circ C$ unless otherwise specified

Characteristic	Symbol	Value	Unit
Drain Source Voltage	$V_{DSS}$	30	V
Gate-Source Voltage	$V_{GSS}$	$\pm 20$	V
Drain Current (Note 1)	$I_D$	$T_A = 25^\circ C$	5.8
		$T_A = 70^\circ C$	4.2
Drain Current (Note 1)	$I_{DM}$	20	A
Body-Diode Continuous Current (Note 1)	$I_S$	2.0	A

## Thermal Characteristics

Characteristic	Symbol	Value	Unit
Total Power Dissipation (Note 1)	$P_D$	1.4	W
Thermal Resistance, Junction to Ambient @ $T_A = 25^\circ C$ (Note 1)	$R_{\theta JA}$	90	$^\circ C/W$
Operating and Storage Temperature Range	$T_J, T_{STG}$	-55 to +150	$^\circ C$

## Electrical Characteristics @ $T_A = 25^\circ C$ unless otherwise specified

Characteristic	Symbol	Min	Typ	Max	Unit	Test Condition
<b>OFF CHARACTERISTICS (Note 4)</b>						
Drain-Source Breakdown Voltage	$BV_{DSS}$	30	—	—	V	$V_{GS} = 0V, I_D = 250\mu A$
Zero Gate Voltage Drain Current	$I_{DSS}$	—	—	800	nA	$V_{DS} = 30V, V_{GS} = 0V$
Gate-Body Leakage	$I_{GSS}$	—	—	$\pm 80$ $\pm 800$	nA	$V_{GS} = \pm 20V, V_{DS} = 0V$ $V_{GS} = \pm 25V, V_{DS} = 0V$
<b>ON CHARACTERISTICS (Note 4)</b>						
Gate Threshold Voltage	$V_{GS(th)}$	1.3	1.9	2.2	V	$V_{DS} = V_{GS}, I_D = 250\mu A$
Static Drain-Source On-Resistance	$R_{DS(ON)}$	—	47	57	mΩ	$V_{GS} = 10V, I_D = 5.8A$ $V_{GS} = 4.5V, I_D = 4.2A$
		—	92	112		
Forward Transconductance	$ Y_{fs} $	—	4.7	—	S	$V_{DS} = 5V, I_D = 4.2A$
Source-Drain Diode Forward Voltage	$V_{SD}$	—	0.78	1.1	V	$V_{GS} = 0V, I_S = 2.0A$
<b>DYNAMIC CHARACTERISTICS</b>						
Input Capacitance	$C_{iss}$	—	268	—	pF	$V_{DS} = 5V, V_{GS} = 0V$ $f = 1.0MHz$
Output Capacitance	$C_{oss}$	—	73	—	pF	
Reverse Transfer Capacitance	$C_{rss}$	—	50	—	pF	

- Notes:
1. Device mounted on FR-4 PCB.  $t \leq 5$  sec.
  2. No purposefully added lead.
  3. Diodes Inc.'s "Green" policy can be found on our website at [http://www.diodes.com/products/lead\\_free/index.php](http://www.diodes.com/products/lead_free/index.php).
  4. Short duration pulse test used to minimize self-heating effect.

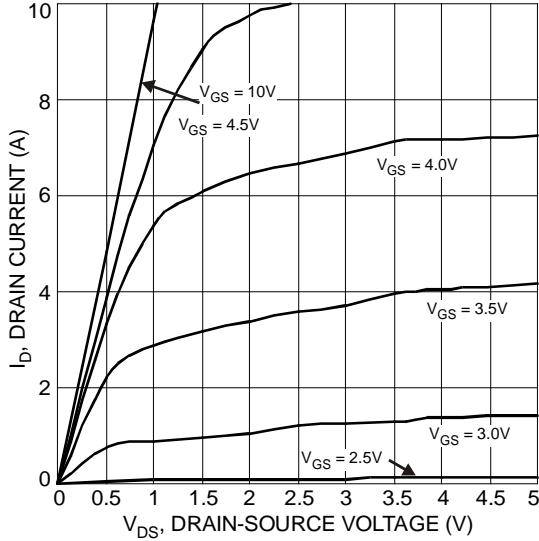

Fig. 1 Typical Output Characteristic

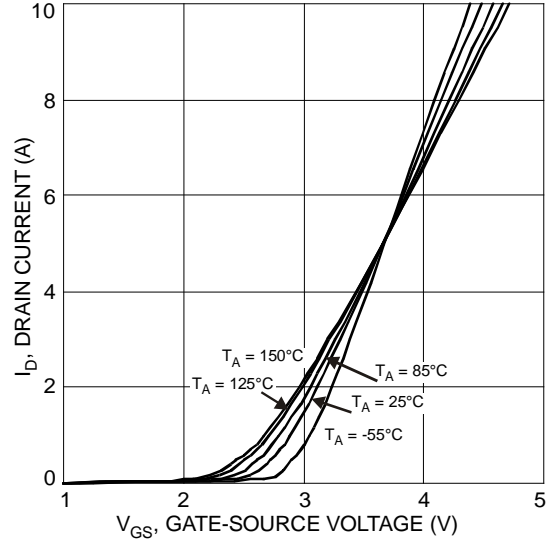

Fig. 2 Typical Transfer Characteristic

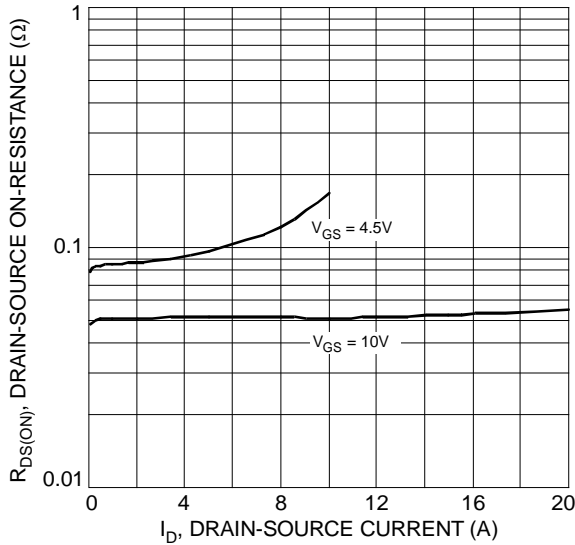

Fig. 3 Typical On-Resistance vs. Drain Current and Gate Voltage

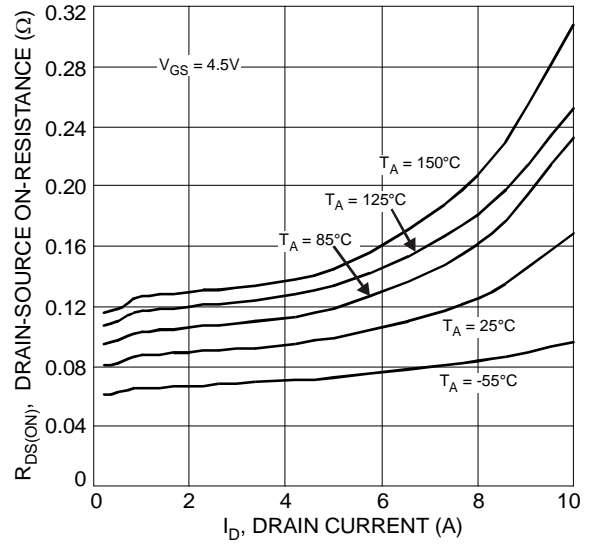

Fig. 4 Typical On-Resistance vs. Drain Current and Temperature

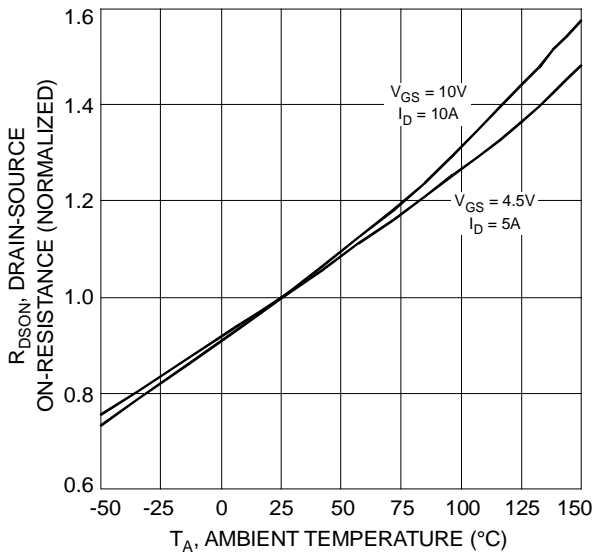

Fig. 5 On-Resistance Variation with Temperature

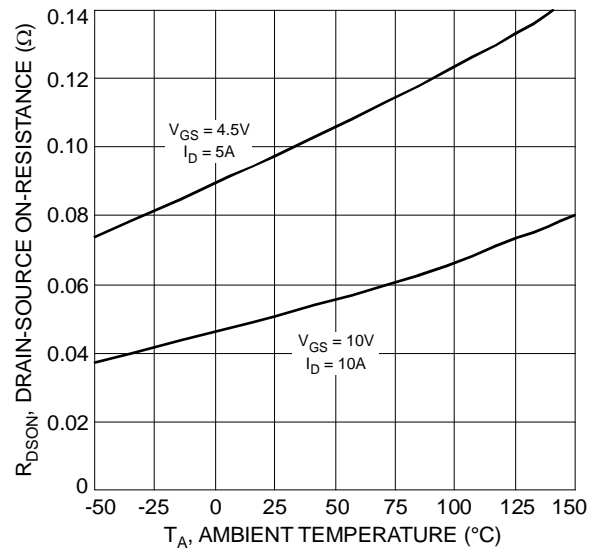

Fig. 6 On-Resistance Variation with Temperature

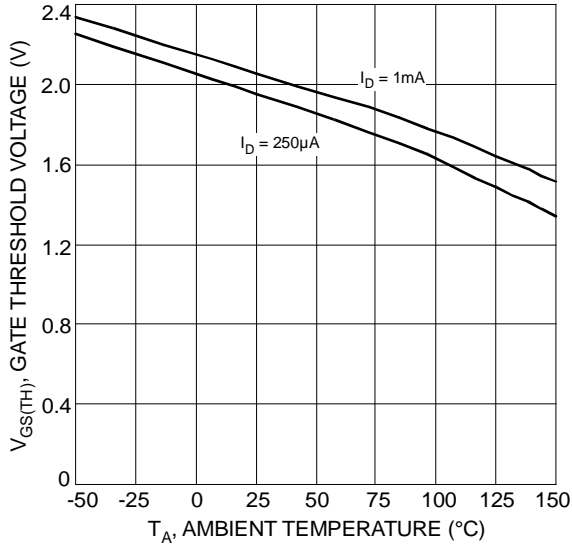

Fig. 7 Gate Threshold Variation vs. Ambient Temperature

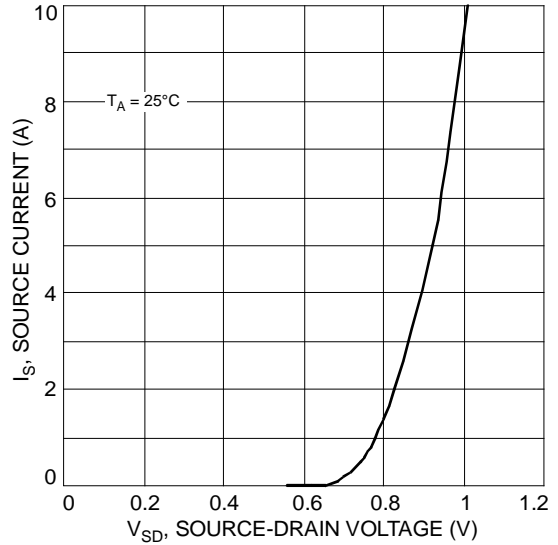

Fig. 8 Diode Forward Voltage vs. Current

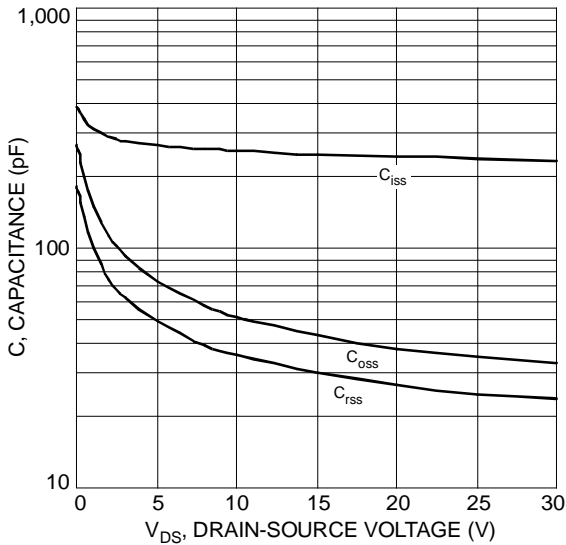

Fig. 9 Typical Total Capacitance

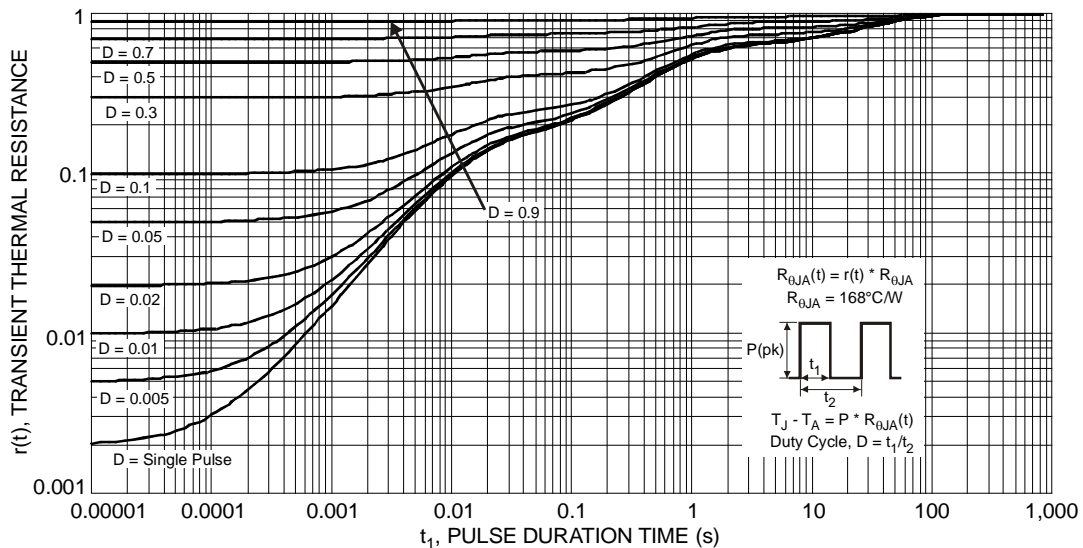

Fig. 10 Transient Thermal Response

**Ordering Information** (Note 5)

Part Number	Case	Packaging
DMN3112S-7	SOT-23	3000/Tape & Reel

Notes: 5. For packaging details, go to our website at <http://www.diodes.com/datasheets/ap02007.pdf>.

**Marking Information**

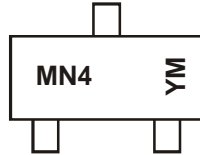

MN4 = Product Type Marking Code  
 YM = Date Code Marking  
 Y = Year (ex: V = 2008)  
 M = Month (ex: 9 = September)

Date Code Key

Year	2008	2009	2010	2011	2012	2013	2014	2015
Code	V	W	X	Y	Z	A	B	C

Month	Jan	Feb	Mar	Apr	May	Jun	Jul	Aug	Sep	Oct	Nov	Dec
Code	1	2	3	4	5	6	7	8	9	O	N	D

**Package Outline Dimensions**

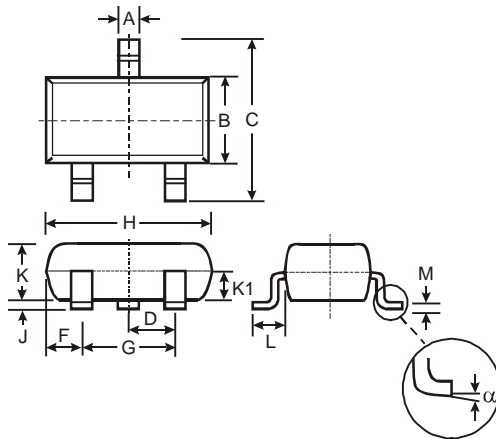

SOT-23			
Dim	Min	Max	Typ
A	0.37	0.51	0.40
B	1.20	1.40	1.30
C	2.30	2.50	2.40
D	0.89	1.03	0.915
F	0.45	0.60	0.535
G	1.78	2.05	1.83
H	2.80	3.00	2.90
J	0.013	0.10	0.05
K	0.903	1.10	1.00
K1	-	-	0.400
L	0.45	0.61	0.55
M	0.085	0.18	0.11
$\alpha$	0°	8°	-

All Dimensions in mm

**Suggested Pad Layout**

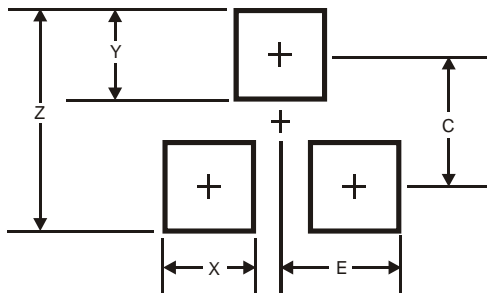

Dimensions	Value (in mm)
Z	2.9
X	0.8
Y	0.9
C	2.0
E	1.35

**IMPORTANT NOTICE**

Diodes Incorporated and its subsidiaries reserve the right to make modifications, enhancements, improvements, corrections or other changes without further notice to any product herein. Diodes Incorporated does not assume any liability arising out of the application or use of any product described herein; neither does it convey any license under its patent rights, nor the rights of others. The user of products in such applications shall assume all risks of such use and will agree to hold Diodes Incorporated and all the companies whose products are represented on our website, harmless against all damages.

**LIFE SUPPORT**

Diodes Incorporated products are not authorized for use as critical components in life support devices or systems without the expressed written approval of the President of Diodes Incorporated.